



TIGER

CRANES

Model 6543 Specifications

Model 6543 Specifications

Dimensional Specifications:

- 30.5' Reach
- 12-30.5' Hydraulic Boom Extension
- 29' Lifting Height
- 44.69" Storage Height
- 172" Overall Storage Length
- Ø18" Mounting Space Required
- 6 Bolt Mounting Pattern
- 3/8" X 120' Winch Cable
- 1920 lbs. Operating Weight
- Ø18" Rotation Clearance Required

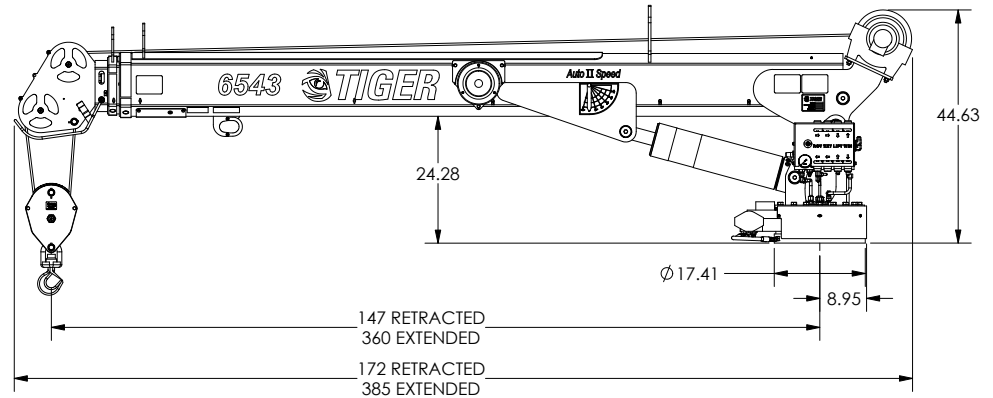

Performance Specifications:

- 43,000 ft-lb Crane Rating
- 47,850 ft-lb Maximum Crane Lifting Moment
- 6,500 lb Double Line Lift Capacity
- 13 second Boom Elevation Time
- 36 second Boom Extension Time
- 1.3 RPM Rotation Speed
- 68 FPM No Load Single Line Speed
- 400 Degrees of Rotation
- -12.5 Degrees to +82 Degrees Boom Angle

Standard Features:

- Wireless pistol grip control with high resolution LCD display for load percentage and diagnostics. Dual joysticks for selecting hydraulic functions with proportional control trigger. Also includes horn, boom lights, compressor, engine start/stop, engine speed control, and 3 auxiliary switches.
- Auto II Speed control reduces maximum speed on all functions when a load is sensed.
- 33' tether cable included for operation without batteries or in areas where radio transmission is not allowed.
- Anti two block & overload protection with condition indicators on remote.
- Stationary rotator gearcase.
- Sealed crane turret.
- Low profile jib head and anti two block mechanism.
- Integrated filtration with bypass condition indicator.
- 12 VDC DO3 10 GPM solenoids with manual overrides & LED On/Off indicator
- Hydraulic planetary winch. Boom mounted for easier stowing.
- Crane lift and extension cylinders are equipped with counterbalance safety valves.
- This crane is designed to meet the requirements of ANSI/ASME B30.5 (2018) and OSHA 1910.180.

Minimum Requirements

- 19,500 lbs. GVW Rating
- 84" Cab to Axle
- 300,000 in-lb frame RBM
- 8 GPM @ 2700 PSI – open center hydraulics
- 43,000 ft-lb rated crane tower reinforcement and outrigger



TIGER

CRANES

Model 6543 Specifications

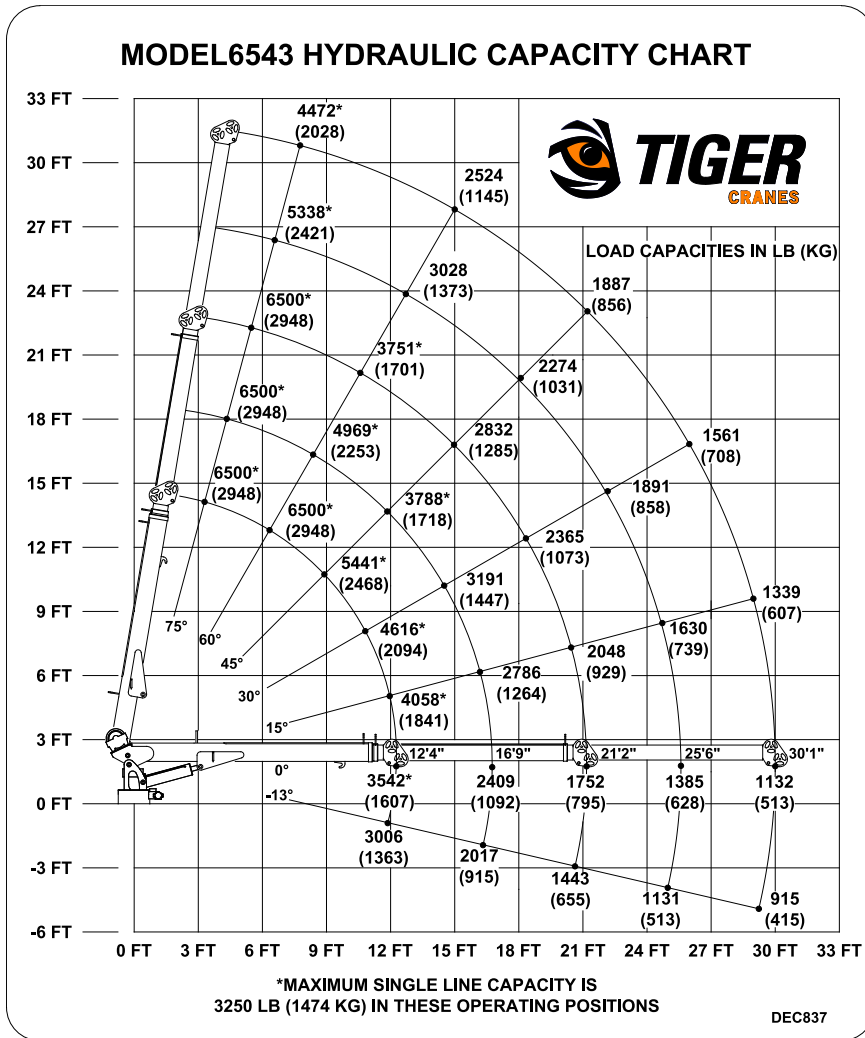

Bolt Hole Pattern

