



TIGER CRANES

Model 3216E Specifications

Model 3216E Specifications

Dimensional Specifications:

- 16.5' Reach
- 7'8"-11'10" Hydraulic Boom Extension
- 11'10"-16'6" Manual Boom Extension
- 15' Lifting Height (from base of crane)
- 32.5" Storage Height (from base of crane)
- 107" Overall Storage Length
- 14"X14" Mounting Space Required
- 8" Square Bolt Mounting Pattern
- 1/4" X 80' Aircraft Hoist Cable
- 750 lbs. Operating Weight

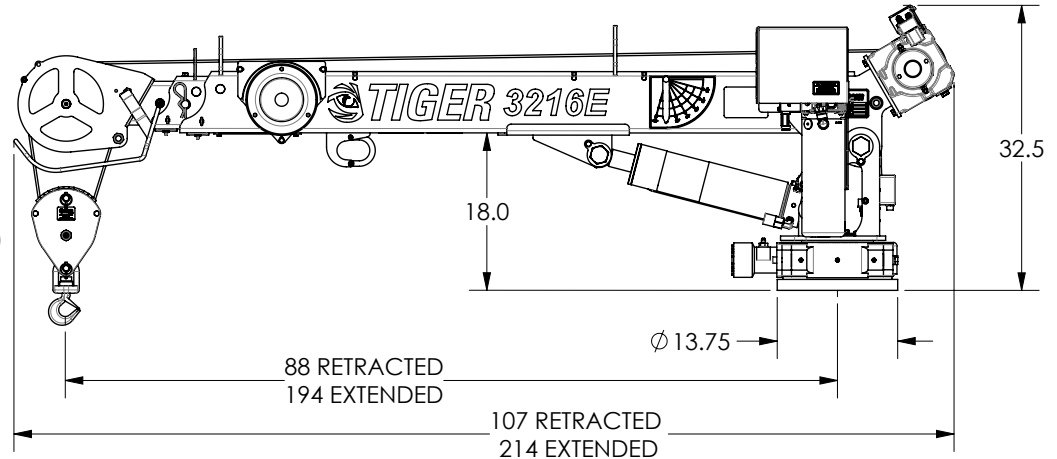

Performance Specifications:

- 12,500 ft-lb Crane Rating
- 13,800 ft-lb Maximum Crane Lifting Moment
- 3200 lb Double Line Lift Capacity
- 400 Degrees of Rotation
- -10 Degrees to +75 Degrees Boom Angle
- Hoist Performance

LINE LOAD	LINE SPEED
0 lbs	22 FPM
500 lbs	19 FPM
1000 lbs	17 FPM
1600 lbs	15 FPM

Standard Features:

- Wireless control with 2 way remote to receiver communication, including hoist, rotate, and boom lift/extend functions. (25' tethered remote control option available)
- 10 VDC Cartridge Valves with manual overrides
- Electric planetary hoist - Boom mounted for easy stowing.
- Sealed turret
- Crane lift cylinder is equipped with a counterbalance safety valve & overload protection.
- Low profile jib head and anti two block mechanism.
- This crane is designed to meet the requirements of ANSI/ASME B30.5 (2011) and OSHA 1910.180.

Minimum Chassis/Power Requirements:

- 11,000 lbs. GVW Rating
- 60" Cab to Axle
- 12,500 ft-lb Rated crane tower reinforcement and outrigger
- 200 Amp Alternator
- 700 Cold Cranking Amp Battery



TIGER

CRANES

Model 3216E Specifications

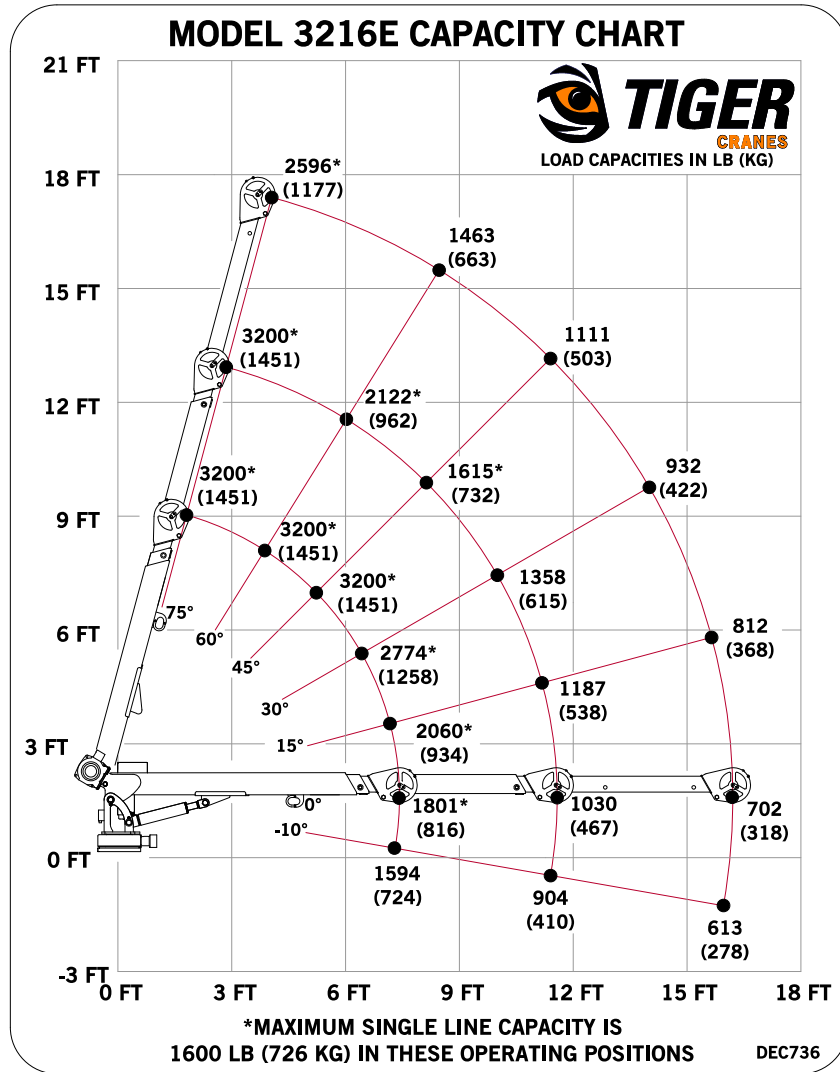

Bolt Hole Pattern

